





# SKANSEN

ASSEMBLY INSTRUCTIONS | CA644

# NOVASOLO.COM

-  (A) 2x Iron Plate
-  (B) 4x Screws
-  (C) 24x Flat Shelf Pins
-  (D) 6x Shelves
-  (E) Wall Mount - Anti Tip Kit

**\* Note:** The L Hex Key is used for both product and wall mount assembly. It can be found in the Wall Mount - Anti Tip Kit (Part E).

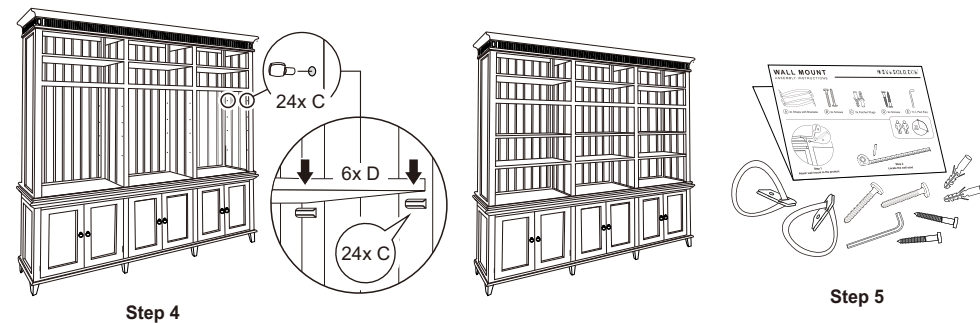
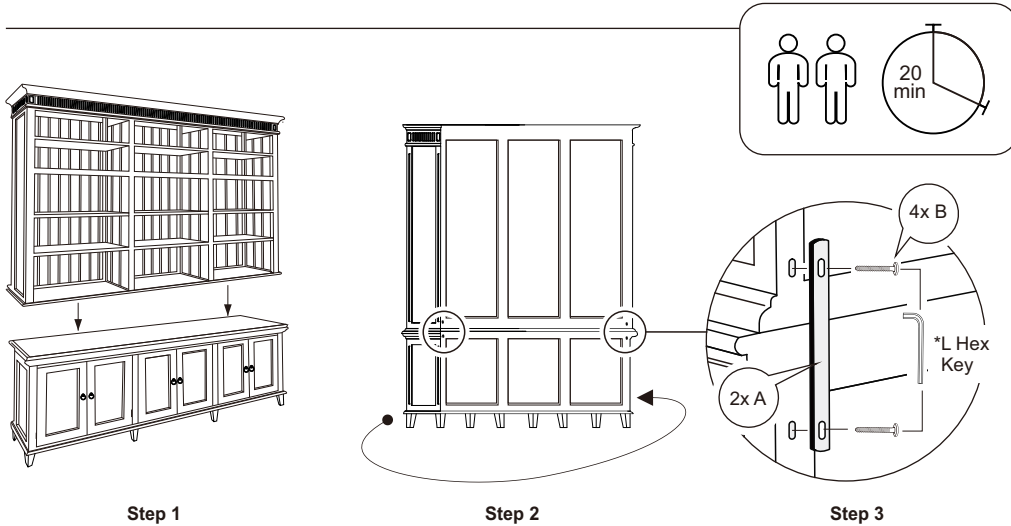





**WARNING**

Always use the proper tools during assembly. Follow the assembly steps in order. DO NOT skip any steps. Be sure to check all packing materials carefully for assembly hardware. If any parts are missing, contact the retailer from which you purchased the product to obtain any missing parts. DO NOT USE SUBSTITUTE PARTS. During assembly tighten screws first by hand. Once all screws are in place use the tool provided to tighten. Periodically check to ensure that all hardware (bolts, screws, etc.) are tight. DO NOT stand on the product during assembly. Where assembly instructions state that assembly requires two or more people, DO NOT attempt to assemble by yourself as there is a risk of injury.

# WALL MOUNT

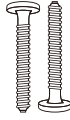
ASSEMBLY INSTRUCTIONS

# NOVASOLO.COM

-  (A) 2x Straps with Brackets
-  (B) 2x Screws
-  (C) 2x Fischer Plugs
-  (D) 2x Screws
-  (E) 1x L Hex Key

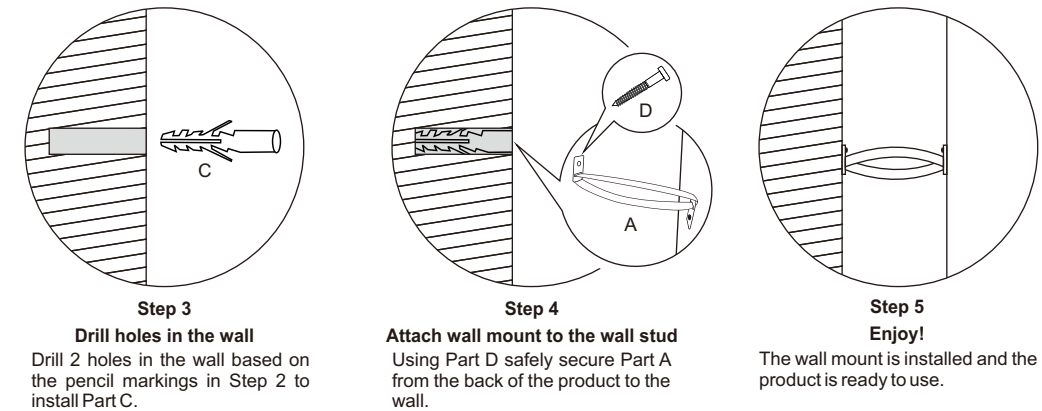
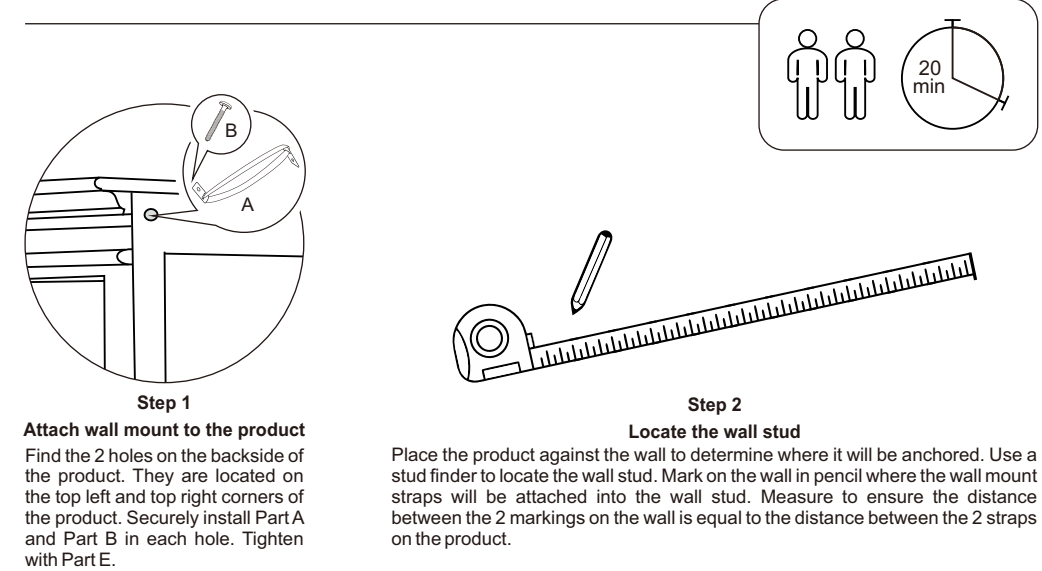

**WARNING**

Serious or fatal crushing injuries can occur from furniture tip-over. To prevent this furniture from tipping over it must be permanently fixed to the wall with the included wall attachment devices. Please note the fastening devices included are not suitable for all wall types. Use fastening devices suitable for the walls in your home. For advice on suitable fastening devices, please contact your local hardware store.